

THESE DRAWINGS ARE THE PROPERTY OF QUALTEK ELECTRONICS AND NOT TO BE REPRODUCED FOR OR COMMUNICATED TO A THIRD PARTY WITHOUT THE EXPRESS WRITTEN PERMISSION OF AN OFFICER OF QUALTEK ELECTRONICS.

REVISION			
REV.	DESCRIPTION	DATE	APPROVED
B	Updated Pin Out, Notes and Graphics	01-27-14	LY

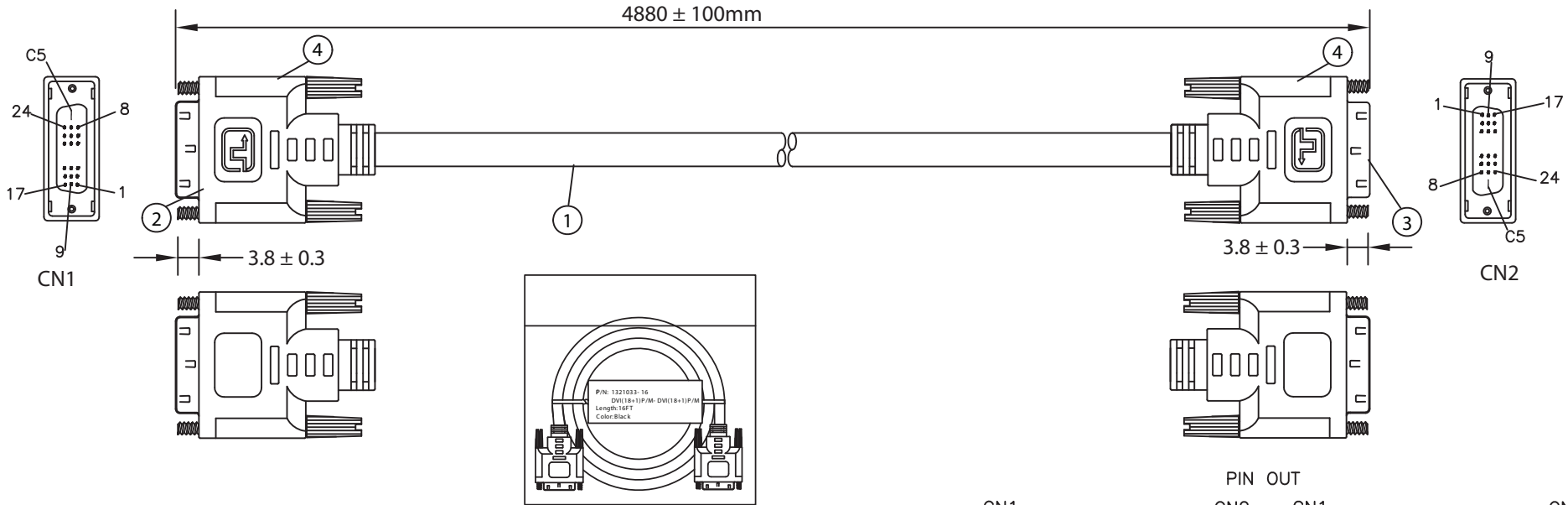

NOTES:

- CABLE: UL20276
(28AWG*1PR+EAM)*4+28AWG*1PR+28AWG*3C+AEB(AL) 65%
OUTER JACKET: BLACK, OD: 7.0 ± 0.2mm
- CONNECTOR: DVI 18+1 MALE
INSULATOR: BLACK
PIN G/F
NICKEL PLATED SHELL
THUMB SCREW: 2.8*32.5 4-40UNC
- CONNECTOR: DVI 18+1 MALE
INSULATOR: BLACK
PIN G/F
NICKEL PLATED SHELL
THUMB SCREW: 2.8*32.5 4-40UNC
- PVC MOLDED: COLOR V398 30P BLACK
- ELECTRICAL TEST:
<1>.100% OPEN SHORT & MISS WIRE TEST
<2>.INSULATION RESISTANCE: AC300V DC400V 10M ohm MIN.
<3>.CONDUCTOR RESISTANCE: 4 ohm MAX.
- PACKING: 1PC/POLYBAG

PIN OUT

CN1		CN2		CN1		CN2	
1	WHITE	1	WHITE	15	WHITE	15	WHITE
2	BROWN	2	VIOLET	16	VIOLET	16	VIOLET
3	DRAIN	3	WHITE	17	WHITE	17	WHITE
6	YELLOW	6	GREEN	18	GREEN	18	GREEN
7	ORANGE	7	DRAIN	19	DRAIN	19	DRAIN
9	WHITE	9	WHITE	23	WHITE	23	WHITE
10	RED	10	BLUE	24	BLUE	24	BLUE
11	DRAIN	11	DRAIN	22	DRAIN	22	DRAIN
14	RED	14	SHELL	SHELL	BRAID & DRAIN	SHELL	SHELL

CONTROLLED

Dim range (mm)	Tolerance +/- (mm)	Qualtek Electronics Corp. WCI DIVISION		
		Part Number: 1321033-16	RoHS Compliant	
0-1	0.15	Description: DVI (18+1)P/M - DVI (18+1)P/M		
1-6	0.20	UNIT: mm REV.B		
6-18	0.30	Drawn / Date	Checked / Date	Approved / Date
18-50	0.50	B. Grubb 01-24-07	01-24-07	JJH / 01-24-07
50-120	0.70			
120-250	0.90			
250-500	1.20			